

7 UHQFK 026 %DUULHU 6FKRWWN\ 5H

d^Wîisîî
dKrîñî

Features

- ‡ \$GYDQWUHQFK WHFKQRORJ\
- ‡ /RZRUZDURGDWDJH GURS
- ‡ /RZRZURVVHV
- ‡ +LJHILFLHQF\ RSHUDWLRO
- ‡ /HDGH)HLQLVK &R#6OLDQW

ï

1

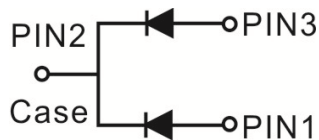

Applications

- ‡ '&' & RQYHUWHUV
- ‡ \$&' & GDSWRUV
- ‡ 6ZLWFKRZHXSSOLHV
- ‡)UHHZKH'HLRGLJ

Maximum ratings and electrical characteristics (T_J = 25°C unless otherwise noted)

3DUDPHWHU		6\PERO	/LPLW	8QLW
0D[LPHSHVSHUNYHYURQWDJH		9550		9
0D[LPHYHURJHJDUGUFXJWHIOWG GHYLFH) \$9 SHU GLRGH				\$
3HDNIRVZDURBUHQWVLCDDHQHZDYH VXSHULPSRVHGRSGLDVGHG)60		\$
2SHUDMXQDQURWRUDJH WHPSHUDW		X0H70D*QJH	WR	f&
7\SLFVCHUPDOUSHVULVQHDQFH		72	5\$-\$	f& :
,QVWDQWDQHRRURWRUJZDUG SHGLRGH		9)	7<3	0\$;
	,) \$		7- f&	9
	,) \$		7- f&	
	,) \$		7- f&	
,QVWDQWDQHRXUUSHQWRDWH UDWHYHYURQWDJH		,5		
			7- f&	P\$

1RWHV

3XOVH WHVVSXOVH ZLGWK GXW\F\FOH

3XOVH WHVW 3XOPH ZLGWK 0

RATINGS AND CHARACTERISTICS CURVES 7\$ f & X Q @ M K H Q Z L W H H G

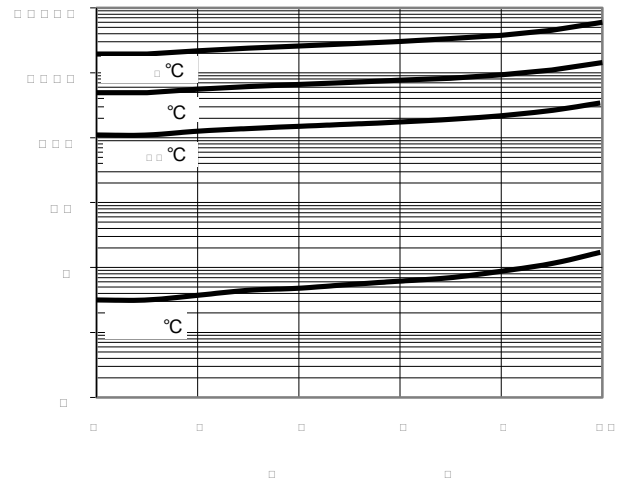
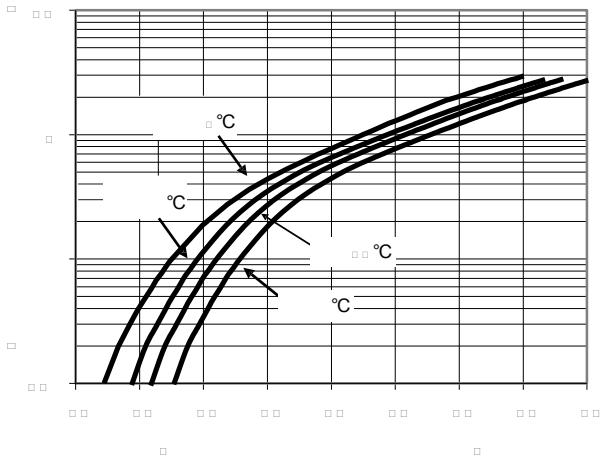
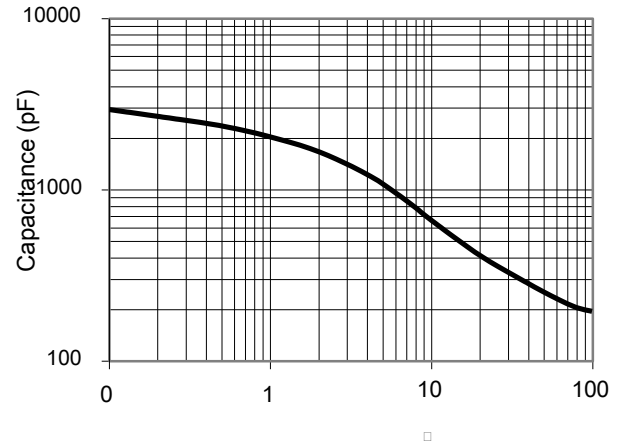
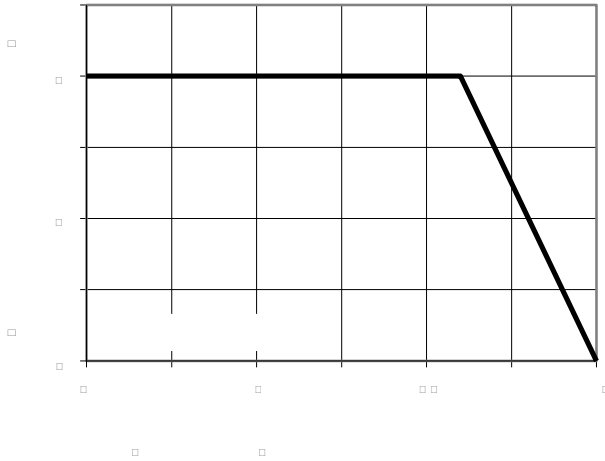

PACKAGE OUTLINE DIMENSIONS

1 R W H X Q L W , Q P P

0DUNLQJ ,QIRUPDWLRQ

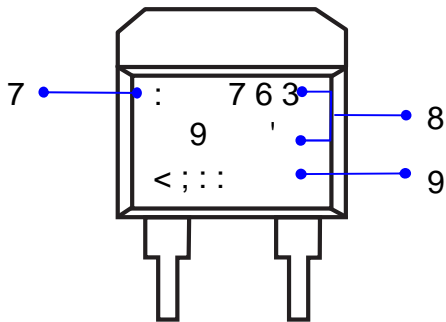

7: &RPSDQ\ V WUDGHPDUN
83URGXFWR PRGHO 763 9 '
93' & LQIRUPDWLRQ
< ; ::

:: :HHN FRGH WR
; ,QWHUQDO LGHQWLILFDWLRQ
< <HDU FRGH H[

3DFNDJLQJ ,QIRUPDWLRQ

5HHO 'LPHQVLRQV

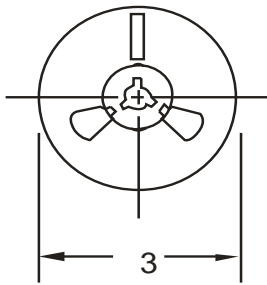

,QVLGH %R[

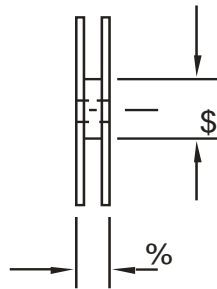

2XWVLGH %R[

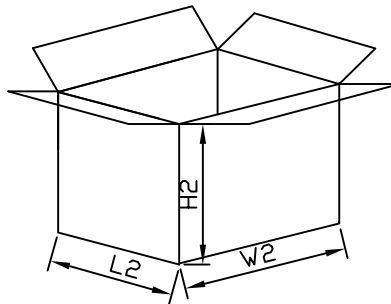
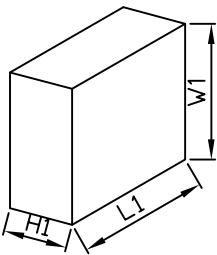

3DFNDJLQJ ,QIRUPDWLRQ

12	81,7	5HHO 'LPHQVLRQV			,QVLGH %R[2XWVLGH %R[
6L]H	PP	&	\$	%	/	:	+	/	:	+
47<	3&6	6PDO	SDFWDJH	3&6	UHHO	&6	UHHO	WRWDO	3&6	FDUVERQHW
1RWH		7ROHUDQFH PP" PP			PP" PP			PP" PP		