

7UHQFK 026 %DUULHU 6FKRWWN\ 5H

763 9 63
TO-277

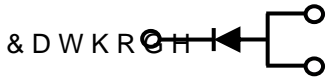

&DWKRCH \$QRGH

)HDWXUHV

‡ \$GYDQWUHQFK WHFKQRORJ\ \\
‡ /RZRUZVROWDJH GURS
‡ /RZRZURVVHV
‡ +LJHILFLHQF\ RSHUDWLRO
‡ /HDGHLQLVK &RPSOLDQW

\$SSOLFDFWLRQV

‡ '& '& &RQYHUWHUV
‡ \$\$ '&\$GDSWRUV
‡ 6ZLWFKRZHXSSOLHV
‡)UHHZKHHLRQJ

0D[LPXP UDWLQJV DQG HOHFWULFDJ& FXODDWHVHUQRWHIGV

3DUDPHWHU		6\PERO	/LPLW	8QLW
0D[LPXPHSHVSHUNYYHYURQWDJH		9550		9
0D[LPXPYHURJHZDUG UFXEWHIQWG		,) \$9		\$
3HDN IRVZDUEBUUHQW VLKDDHQZDYH VXSHULP&QDWHCRS&GGLRGH		,) 60	0	\$
2SHUDMXQDQCRQWRUDJH WDESHUDW XUH 767			WR	f&
7\SLFDO WKHUPDO UHVLVWDQFH SHU		GLSR&H	ORXQWHG RQ)5	3&f% :
,QVWDQWDQHRROWRUJZDUG SHGLRGH	,) \$	7- f&	7<3	0\$;
	,) \$	7- f&		
	,) \$	7- f&		8
	,) \$	7- f&		
,QVWDQWDQHRXUUSHOMRQWH UDWHYHYURQWDJH	7- f&	,5		X\$
	7- f&		5	P\$

1RWHV

3XOVH WHVVSXOVH ZLGWK GXW\ F\FOH

3XOVH WHVW 3XOPH ZLGWK 0

5\$7,1*6 \$1' &+\$5\$&7(5,67,&6 &7859(6f& XQOHVQRWKB UZLVH

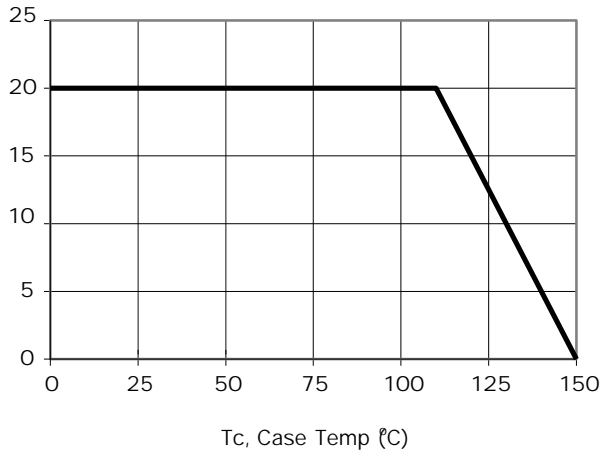

& D S D F L W S D Q F H

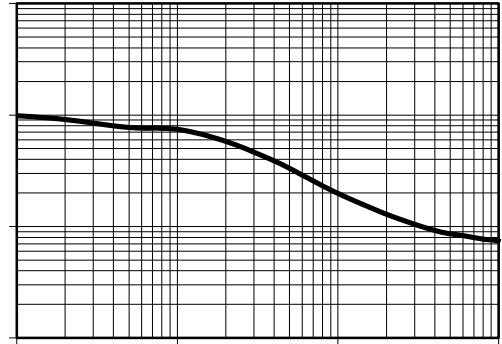

Reverse Voltage (V)

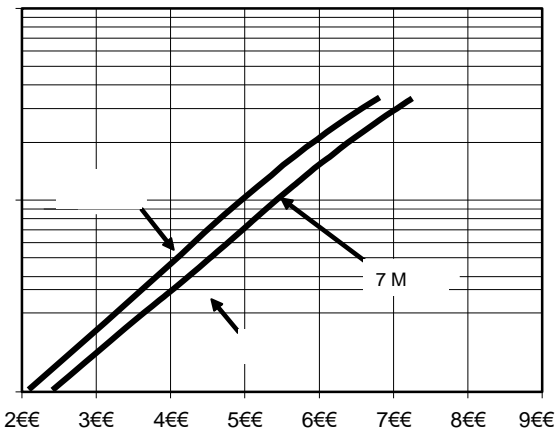

, U 5 H Y H U V H X S X U U H Q W

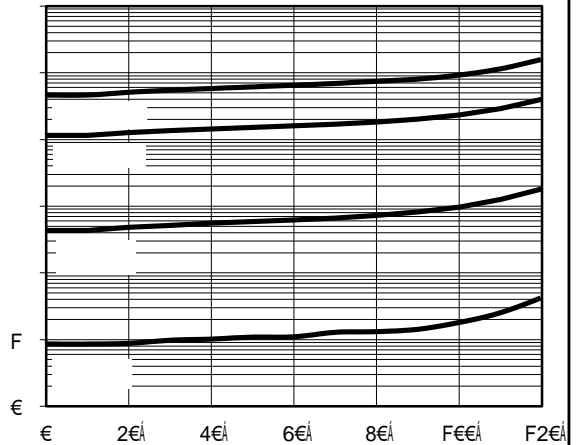

3 \$ & . \$ * (2 8 7 / , 1 (' , 0 (1 6 , 2 1 6

TO-277

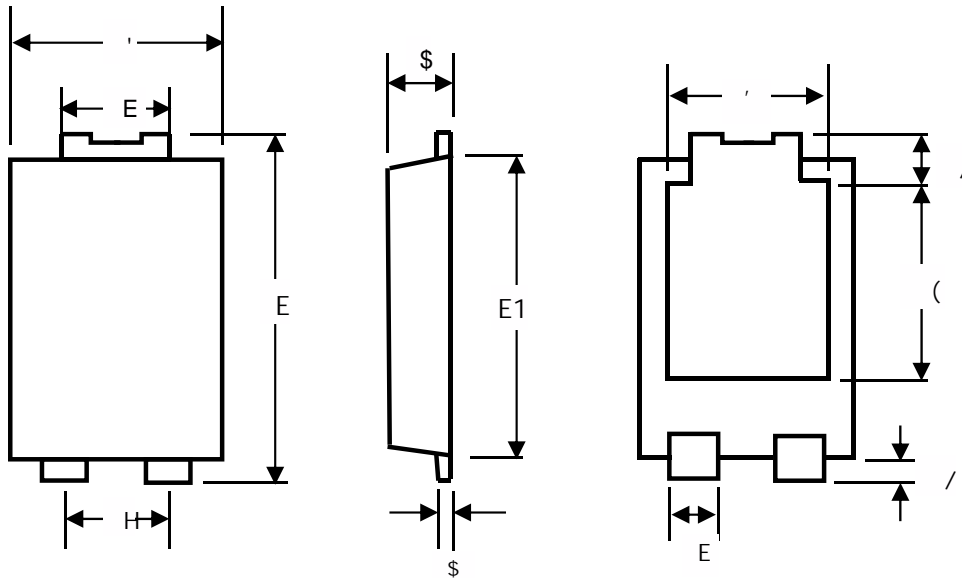

7 2 M D

T			2		2	D	D			2		ŠF
{ {	{ øç	FÈH	€ÈI	FÈ€	FÈJ	IÈH	HÈ€Í	ÎÈÎ	ÍÈÍ	HÈÍÍ	1ÈO	OÈÏ
	{ à}	1È1	OÈG	OÈÌ	1ÈÏ	HÈJ		ÎÈÌ	ÍÈH		OÈÌ	OÈÍ
{ à}	{ øç	ÍFÈFÌ	FÍÈÍÍ	HJÈHÏ	ÏÍÈÈ€	FÍJÈH	F2€È€	2ÍJÈÌ	GGÍÈH	1HJÈÏ	HJÈHÏ	GÍÈÍÍ
	{ à}	IHEHO	ÏÈÏ	H1ÈIJ	ÏÍÈJH	1ÍÈÈÍ		GÍGÈO	GOÍÈÏ		H1ÈIJ	1JÈÍJ

VUÈ2ÏÏ 6 X J J H V W D H G D \ R X W

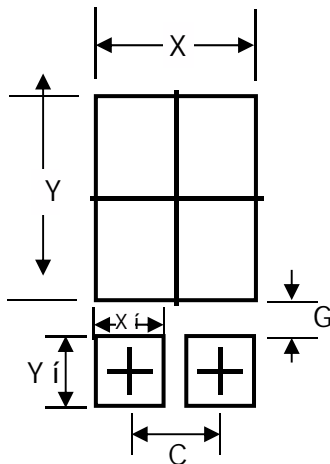

8 1 , 7		Ô	Õ	Ý	Ý1	ÿ	ÿ1
{ {	{ à}	1ÈIO	OÈJO	HÈI	1ÈI	IÈJ	1ÈI
{ à}	{ à}	ÏÍÈÏÏ	HÍÈIH	1HHÈÏÏ	HÍÈIH	1JGÈJ1	ÍÍÈ1G

0DUNLQJ ,QIRUPDWLRQ

73URGXFW PRGHO 75BIHUU63
WR DV 9

83' & LQIRUPDWLRQ

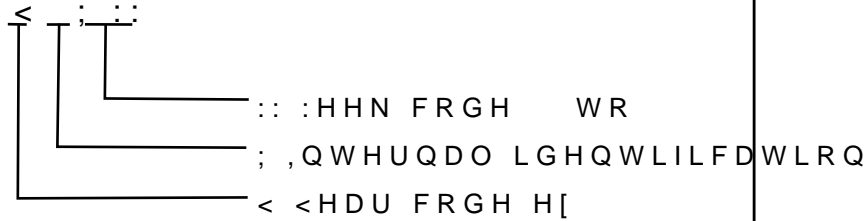
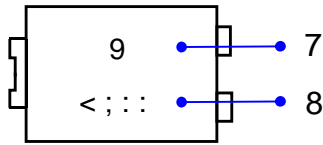

3DFNDJLQJ ,QIRUPDWLRQ

5HHO 'LPHQVLRQV

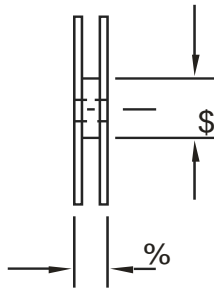
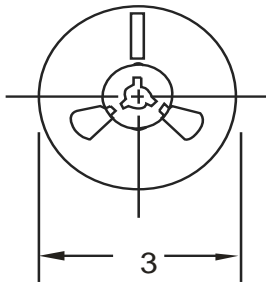

,QVLGH %R[

2XWVLGH %R[

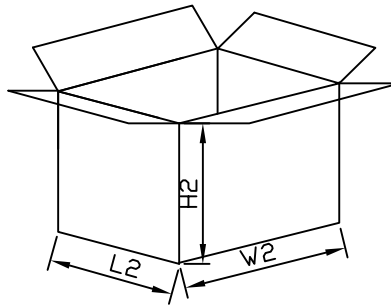
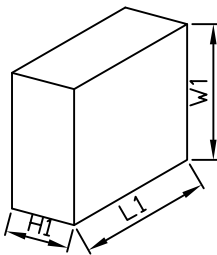

3DFNDJLQJ ,QIRUPDWLRQ

12	81,7	5HHO'PHQVLRQV			,QVLGH %R[2XWVLGH %R[
		&	\$	%	/	:	+	/	:	+
6L]H	PP									
47<	3&6	6PDOOHVW SDFNDJH			3&6 UHHO			3&6 & 6 JHFOUWLRQ		
1RWH		7ROHUDQFH PP" PP			PP" PP			PP" PP		