

7 UHQFK 026 %DUULHU 6FKRWWN\ 5H

‡ \$GYDQWUHQFK WHFKQRORJ\
 ‡ /RZRZDWRWDJH GURS
 ‡ /RZRZDWRVHV
 ‡ +LJHILFLHQF\ RSHUDWLRO
 ‡ /HDGHJLQLVK \$RPSOLDQW

‡ '&' &RQYHUWHUV
 ‡ \$&' \$GDSWRUV
 ‡ 6ZLWFKRZHSXSSOLHV
 ‡)UHHZKHHLGQJ

3DUDPHWHU	6\PERO	/LPLW	8QLW
0D[LPXPHSHVSHUNYHYURQHW DJH	9550		9
0D[LPXPYHURJHZDUG UFXEWHIQWG	,) \$9		\$

3HDN IRVZDUEBUUHQW VLQDQHQZDYH
 VXSHULPSQNDVHRLG/KL,) `0

1RWHV

3XOVH WHV\$XOVH ZLGWK GXW\ F\FOH

3XOVH WHVW 3XOPWH ZLGWK 0

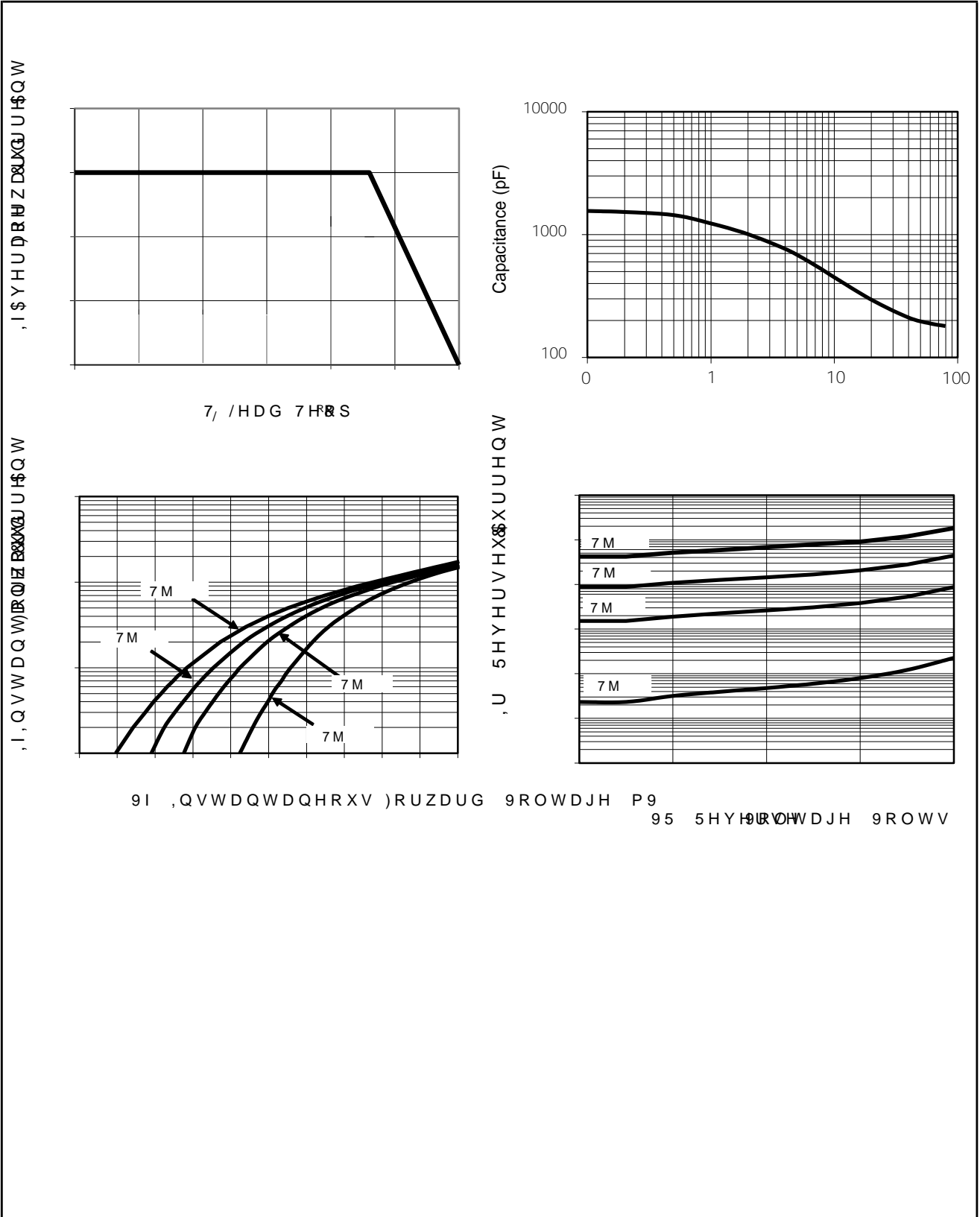

3 \$ & . \$ * (2 8 7 / , 1 (' , 0 (1 6 , 2 1 6

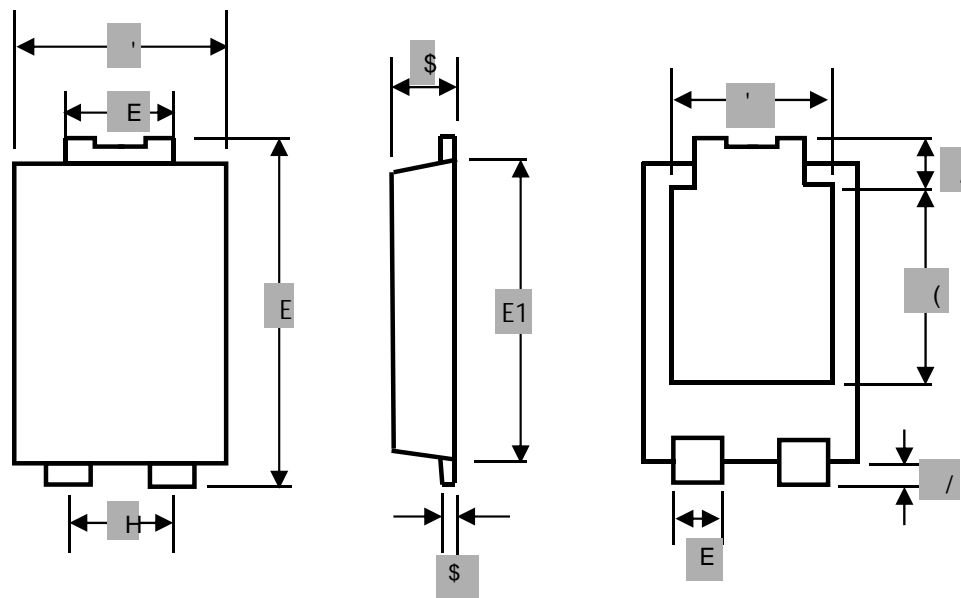

81,7		\$	\$	E	E	'	'	(((/	/
PP	PD[
	PLQ											
PLO	PD[
	PLQ											

72 6 X J J H V W D H G \ R X W

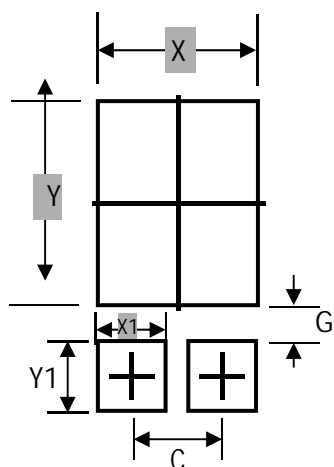

81,7		&	*	;	;	M	M%
PP	PLQ					(" -	% (
PLO	PLQ					% & " - %)	" % &

3URGXFW PRGHO 5H3HUU63
WR DV /

83' & LQIRU EDWLRQ

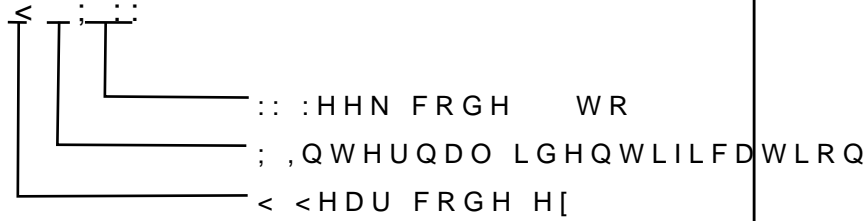
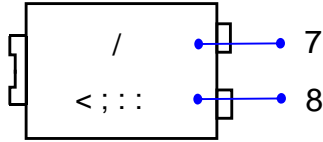

5HHO 'LPHQVLRQV

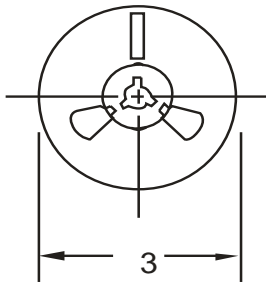

,QVLGH %R[

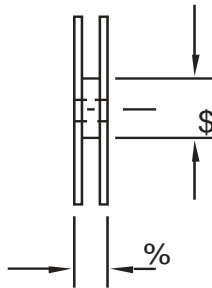

2XWVLGH %R[

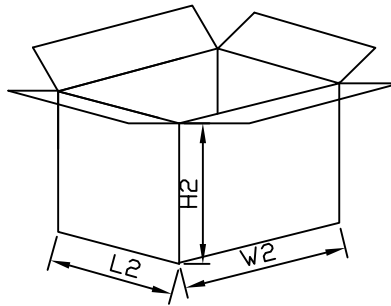
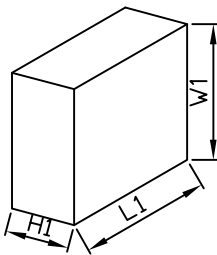

12	81,7	5HH'QPHQVLRQV			,QVLGH %R[2XWVLGH %R[
6L]H	PP	&	\$	%	/	:	+	/	:	+
47<	3&6	6PDOOHVW SDFNDJH			3&6 UHHO			3&6 & 6 HFOURQ R W DOW R W D		
1RWH		7ROHUDQFHP" PP			PP" PP			PP" PP		