



WRLSB40M

129

8OWUDVRIW 5HFRYHU\ %ULGJH



/6% 3DFNDJH

3,11,1*

3,1	'(6&5,37,21
	,QSXWÄÄ Q
	,QSXWÄÄ Q
	2XWSXWÄÄ QRGH
	2XWSXWÄÄ WKRGH

)HDWXUHV

‡*ODV DVVLY &KLSG FWLRQ

‡5HYHURDWDJH9

‡)RUZDUGUHSW

‡+LJXU &XUUHQSD ELOLW\

‡'HVLJQRG XUIDRHS S SOLFDWLRQ

%HQHILWV

‡ &DVH %

‡7HUPLGRG HGBH7'

‡5HGXFHG (0, 5HGXFHG SRZHU

DQG VZLWFKLQJ WUDQVLYW

0D[LPXPDWLQGOHFWKBD OFWHULVWLFV

5DWLQV &PEL MGH SHUXDUMK HUSLHFLILHG

6LQJOH SKDVH KQIHZD VMLQGXFORIDHSDSDFLWEXHURDWH

3DUDPHWHU	6\PEROV	:5/6% 0	8QLWV
0D[LPXP 5HSHWLWLYH 3HDN 5950U	VH 9ROWDJH		9
0D[LPXP 506 YROWDJH	9506		9
0D[LPXP '& %ORFNLQJ 9ROWDJH &			9
\$YHUDJH 5HFWLILHG 2XWSXW &RUUHQW			\$
5HYHUVH 5HFRYHU\ 7LPH ,) \$,5 \$,55 \$	7UU		XV
3HDN)RUZDUG 6XUJH &XUUHQW +DOI 6LQH :DYH 6XSHULPSRV, HGO RQ 5DWHG /RDG -('(& 0HWKRG		PV 6LQJOH RQ 5DWHG	\$
, WUDWROXVLQBV W PV	, W		\$ 6
0D[LPX)RUZDUG WDW H\$	9)		9
0D[LPXP '& 5HYHUVH &XUUHQW #7\$ DW 5DWHG '& %ORFNLQJ 9ROWDJH #7\$	f & f &		\$
7\SLFDO -XQFWLRQ &RVSDFLWD &MH			S)
2SHUDWLQJ DQG 6WRUDJH 7HPSW WDWXUH 5DQJH a			f &
7\SLFDO WKHUPDO UHVLVWDQJ 5WK 1\$ 5WK 1\$			f & :
1RWH0HDVX DWG+]DQGSSOLLHGHYURDWRD JH& 0RXQWHG RQ JODVV HSR[\ 3& ERDUG ZLWFRSSHU SDG			

: 5 / 6 % 05HY

: RUOG , QWH & QUDWLFLQDHOG

RATINGS AND CHARACTERISTICS CURVES 7\$ ° & XQOHVV RWKHUZZLVH QRWHG

7 F & DVH 7&HPS

Current Derating, Case

WRLSB40M

129

3 \$ & . \$ * (287 / , 1 (' , 0 (16 , 2 16

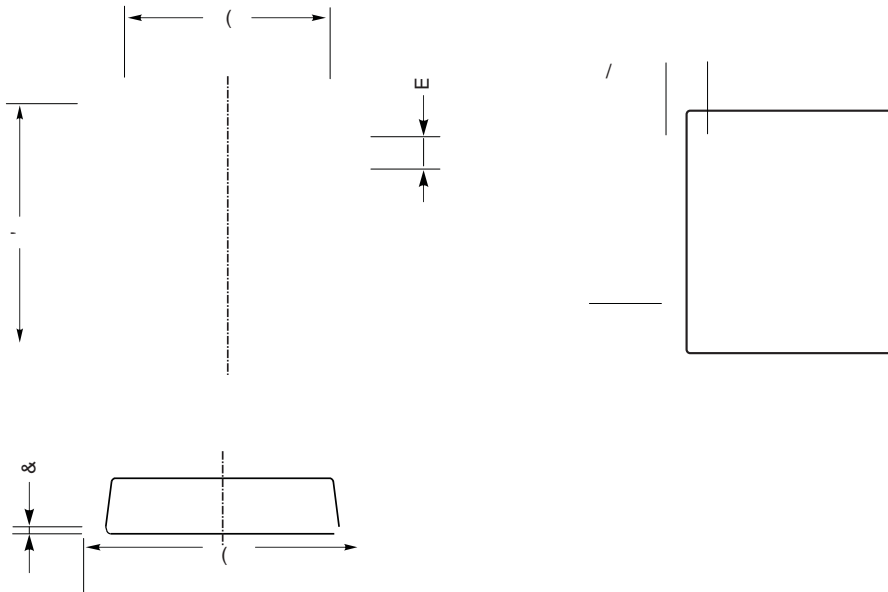

/ 6 % P H F K D Q G L F W D

8 1 , 7		\$	&	'	(&	/	H	E
PP	PD[
	PLQ								
PLO	PD[
	PLQ								

/ 6 % 6 X J J H V W H G 3 D G / D \ R X W

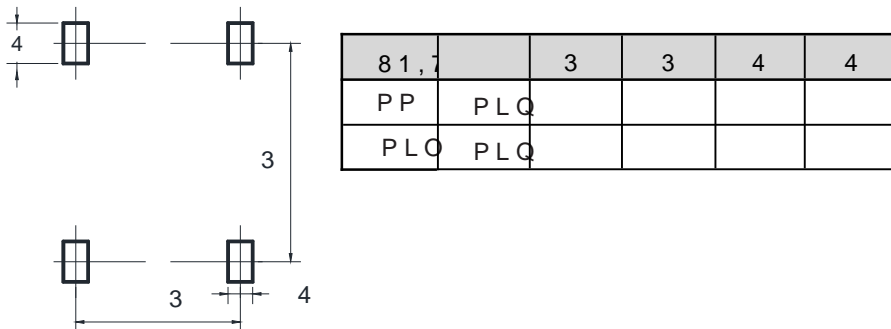

' L P H Q V I L R / Q R / L O O L P H W H U V



WRLSB40M

0DUNLQJ ,QIRUPDWLRQ

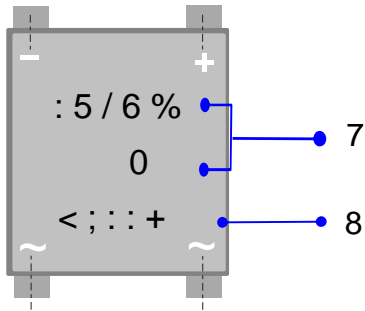

73URGXFW P5R 6% 00
83' & LQIRUPDWLRQ

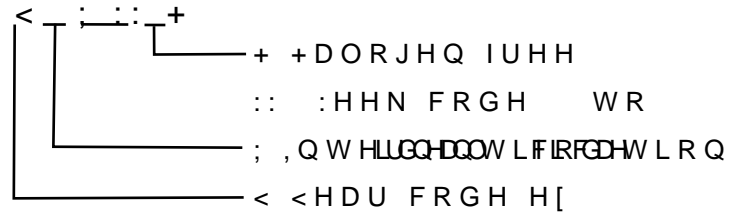

3DFNDJLQJ ,QIRUPDWLRQ

5HHO 'LPHQVLRQV

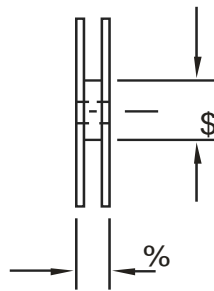
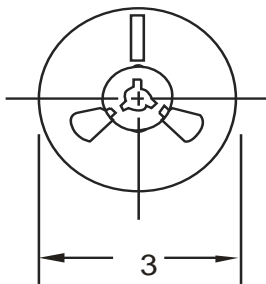

,QVLGH %R[

2XWVLGH %R[

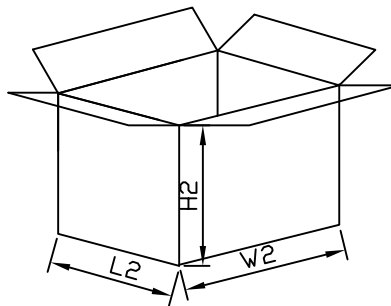
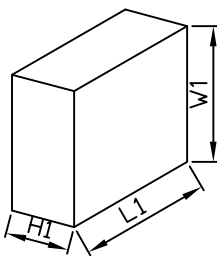

3DFNDJLQJ ,QIRUPDWLRQ

12	81,	5HHO 'LPHQVLR			,QVLGH %R[2XWVLGH %R[
6L]H	PP	&	\$	%	/	:	+	/	:	+
47<	3&6	6PDOGHVFWDJH3&6 UHHO			3&6 UHHO RWDO			3&6 FDUERPRQ RWDO		
1RWH		7ROHUDQFH PP" PP			PP" PP			PP" PP		